



**INDUSTRIAL VACUUM SOLUTIONS
FOR COMBUSTIBLE DUST**

ATEX ACD





**THE GLOBAL SPECIALIST FOR DUST
MANAGEMENT ACROSS ALL INDUSTRIES**

OUR GOAL: YOUR SAFETY

The vast majority of manufacturing and production processes involve the generation or handling of hazardous dust, powders and other materials that represent a threat to the environment and the operators' health and safety on the workplace.

For employers across the world that need to keep their production environment safe and clean, it is increasingly mandatory to implement effective solutions, such as integrated vacuum systems, dust collectors and filtration systems to extract at the source hazardous particles, to prevent spillages during production, contamination of the environment and products, and exposure of operators to risks such as explosion and diseases generated by breathing harmful substances.

Since more than thirty years, the Delfin Groups works hard every day to develop innovative solutions for cleaning, extracting and handing of countless types of dusts and materials across all industries, and stands out today as the global specialist for industrial dust management.

COMBUSTIBLE DUST HAZARDS ACROSS DIFFERENT INDUSTRIAL SECTORS AND APPLICATIONS

There are several definitions, classifications and technical standards clarifying when and to what degree a specific dust is combustible; a general and unanimously agreed upon condition to classify as combustible a specific dust resulting from a manufacturing process, is that its average size should be lower than 500 micron. This is the result of testing carried out on more than 7.000 sample of multiple particles from materials in almost all industrial manufacturing processes.

Areas classified as subject to high risk of explosion, are those where production or handling of large quantities of dust result into a high concentration of combustible materials. Those areas include silos and production (drying, milling, refining of raw ingredients).



Areas with high risk of explosion, due to the manipulation or production of combustible dust, include silos and work zones for the drying, milling, and refining of raw materials.



Various machining processes in the metalworking and wood sector generate dangerous powders, particularly during sanding, grinding, drilling, cutting, satin finishing, and varnishing phases.



Transformation of chemical or pharmaceutical raw materials include activities such as granulation, milling, compressing, coating, tableting, and packaging of potent powders or hazardous substances.



In the oil & gas, power plants and mining industries, higher level of risk are common due to accidental leaks or spillages, or frequent presence of combustible residues.



Explosive powders can be generated during the transportation and storage of plastic or rubber granules. The risk is higher in areas such as milling operations, powder storage and separation systems



The evolution of production processes through innovation generates new requirements related to handling and extracting combustible dust: in additive manufacturing polymer and metal powders need to be loaded into printers, extracted from the building chamber and cleaned out of finished parts.

INDUSTRIAL PROCESSES AND COMBUSTIBLE DUST



ACD INDUSTRIAL VACUUM CLEANERS FOR COLLECTION OF COMBUSTIBLE DUST IN ORDINARY / NON ATEX CLASSIFIED LOCATIONS

- Vacuum cleaners tested and certified by third party as zone 20 internal (Ex 1/ - D) compliant
- Two stages filtration (class M + H14 / HEPA efficiency) for double protection against penetration of dust inside the motor head
- Integrated AISI304 stainless steel container; optional endless bag for continuous disposal and inert system for highly reactive powders available.



ATEX 22/21/20 / -CERTIFIED SINGLE PHASE VACUUMS FOR POWDERS, SOLIDS OR LIQUIDS

- Industrial vacuum cleaners certified by third party for ATEX zone 20 internal and for ATEX zone 22 or 21 external
- Brushless motor version, maintenance free, available for continuous use
- Two stages filtration (class M + H14 / HEPA efficiency) for double protection against penetration of dust inside the motor head
- Integrated AISI304 stainless steel container; wide range of options (full stainless steel construction, PTFE filtration) available
- IECEX/ NFPA DIV.1 - 2 versions also available



ATEX 22/21/20 - THREE-PHASE VACUUMS FOR HEAVY DUSTY APPLICATIONS 24/24H IN ATEX CLASSIFIED AREAS

- Three-phase industrial vacuum cleaners certified by third party for ATEX zone 20 internal and for ATEX zone 22 or 21 external
- Two stages filtration level for double protection with HEPA efficiency
- Wide range of options with AISI304 stainless steel and automatic filter cleaning systems ATEX compliant
- Maintenance free high performance vacuum unit up to 18.5 kW for heavy applications and non stop duty
- IECEX/ NFPA DIV.1 - 2 versions also available



INERT SOLUTIONS FOR CONDUCTIVE / REACTIVE POWDERS (ATEX) FOR CONDUCTIVE AND SELF IGNITING POWDERS

- The INERT collection system designed by Delfin enables to neutralize the risk of explosion when collecting self-igniting, highly combustible powders, that are rendered harmless by being vacuumed into the inertizing liquid inside the collection container.
- Certified by third party for zone 20 internal, and zone 22 or 21 external



ATEX & IECEX CERTIFIED COMPRESSED AIR-OPERATED VACUUMS FOR COMBUSTIBLE DUST AND FLAMMABLE GAS PRESENCE

- Air-powered industrial vacuums certified by third party, zone 20 inside and external zone 22 or 21
- Suitable to work in Zone 1 and 2 with presence of flammable gas
- Specific models available for Hydrogen or class IIC GAS

OUR PRODUCT RANGE

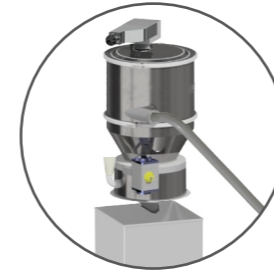

PNEUMATIC CONVEYORS

Delfin pneumatic conveyors use vacuum technology to guarantee transport of powders and solids in production processes, optimizing the performance vs. consumption ratio, accuracy and efficiency.

Designed with a focus on quality and reliability, they are also available with ATEX certificate, in order to comply with the safety standards of industries such as food, chemical, pharmaceutical and additive manufacturing / 3d printing.



DUST COLLECTORS

The main function of an industrial dust collector is to extract at the source airborne dust and particles; they can be used with mobile extraction arms or directly connected for extraction on production machinery.

Their ATEX certified version are highly popular and requested in the food, chemical, pharmaceutical and additive manufacturing/3D printing industries.

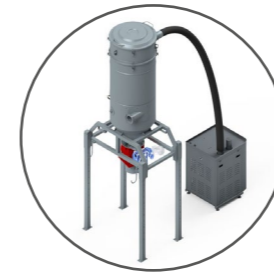

INDUSTRIAL CENTRALISED SYSTEM

Delfin designs and supplies turnkey CVS solutions and systems, to enable efficient cleaning and maintenance across large plants and distances; a powerful suction unit, coupled with collection and filter separators, and fixed piping, enables to maximise performance, reduce the cost of equipment, transport and safely dispose of the collected product at the preferred point. ATEX certified systems and features are the natural and often mandatory choice for production sites working with combustible dust.



DHV

The DHV range has been specifically designed to meet the cleaning and maintenance needs across the heaviest industries, such as cement, steel, power plants, glass, agrifood. Built with ATEX components and certified accordingly ATEX, they are the natural choice in front of challenges to collect large quantities of heavy material at a long range.

ATEX: DELFIN KNOWS HOW

For manufacturers of vacuum cleaners engaging in manufacturing and selling ATEX vacuums, it is mandatory to keep up to date evolving regulations, safety standards, test requirements and methods of protections, and work with regulatory bodies and testing institutes, in order to guarantee that the end user of the equipment is fully protected and aware of its correct use, depending on the safety category it is certified for.

Delfin's Engineering and Regulatory teams work constantly to develop increasingly safe and efficient technical solutions, and constantly discuss their work with international committees of specialists across the globe, certified for their competency in risk management related to explosive environments.

Sharing and learning from the experts across the industry, and adding this to 30+ years of Delfin know how, is the ongoing process that enables Delfin to create innovative machines that are safe, efficient and user-friendly, but offer to business partners and end user customers the guarantee of a safe workplace, with third party certificate by several international notified bodies.

EXPLOSION PROOF MOTOR HEADS AND SWITCHBOXES

BP/BL SERIES

Delfin is the first manufacturer to have designed, tested and obtained 3rd party ATEX certificate for its single phase motor heads, for both ATEX 22 and 21: with official dust protection marking Ex tb, ATEX Category 2D and IECEx EPL Db, Delfin offers the safest solution available on the market, worldwide.

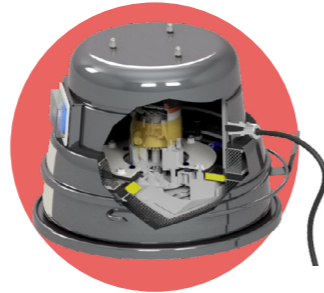

HD SIDE CHANNEL BLOWERS SERIES

During 2024 Delfin will be presenting its innovative and extended range of ATEX side channel blowers (power ranging from 0.4 to 25K), with third party certificate. Designed to maximize the performance vs. energy ratio, they will be suitable to work in ATEX Zone 22 environments, and bear the marking Ex tc, Category 3D.

Options will also be available for Dust Category 2D or for ATEX GAS zones.



ATEX SWITCH BOX

Thanks to its know-how and inhouse engineering in the areas of automation and power controls, Delfin has designed an innovative ATEX switch-box, suitable for vacuum systems with three phase suction units for ATEX Zone 22 and 21, featuring a high resistance in industrial use, and a marking with dust ignition protection Ex tb, Category 2D.



Ex "t" DUST IGNITION PROTECTION METHOD

Delfin enclosures are totally protected against the penetration of dust: so that layer or cloud is excluded from enclosure and hence it does not come in contact with what is contained in. Such protection method must be tested by accredited institutes, that need to carry out a number of compliance tests:

- 1) Thermal and humidity endurance conditioning of the product to simulate aging with temperature set according ATEX categories to achieve.
- 2) Bumping on weaky parts and opening those used for maintenance, to simulate real use and misuse.
- 3) IP testing by projecting fine dust clouds from all directions while internal parts are air underpressure. Only if after such test the inside of the casing will be free of dust, can the enclosure of the electrical parts be certified and marked as IP 6X, in compliance with ATEX.

ZONING		EQUIPMENT PROTECTION		
Gas	Dust	Atex Category	Equipment Protection Levels	Dust Ignition Protection
0		1G	Ga	
	20	1D	Da	Ex ta
1		2G	Gb	
	21	2D	Db	Ex tb
2		3G	Gc	
	22	3D	Dc	Ex tc

ATEX EVOLUTION: THE NEW STANDARD EN17348:2022

The European standard UNI EN 17348:2022 has been harmonized with the ATEX directive since March 2023 and in August it was harmonized also with the machinery directive. The new standard specifies the requirements for design, construction, testing and marking of hand-held, portable, and transportable vacuum cleaners and vacuum systems, including their accessories, intended for the collection of combustible or non-combustible dusts and flammable or non-flammable liquids in potentially explosive atmospheres.

NEW CONCEPT OF FILTRATION BARRIERS IN RELATION TO THE INTERNAL MARKING CATEGORY FOR ZONE 20

FILTRATION LEVEL 1:

MAIN FILTER ISO15E - 95% EFFICIENCY MINIMUM REQUIREMENT

A main filter shall be placed inside the collection tank in order to prevent the majority of collected substances to get into contact with the power system. The dust filtration efficiency of the main filter shall allow at minimum the installation of Category 2D vacuum powerhead or equipment downstream the main filter.

FILTRATION LEVEL 2

HIGH-EFFICIENCY PARTICLE AIR FILTER UPSTREAM HEPA GROUP H - 99,95% EFFICIENCY MINIMUM REQUIREMENT

The second level of filtration is implemented as a backup protection in case the main filter were damaged. To install a Category 3D power system or components inside the vacuum cleaner where the working air pass through, a high efficiency particle air filter shall be placed after the main filter as a second level of filtration.

PRESENCE OF FLAMMABLE GAS ON FILTERING:

If present in the atmosphere in the working environment, Explosive gas will typically not be filtered or affected by the dust filter.

Filtration efficiency measurement standard: ISO 29463:2018

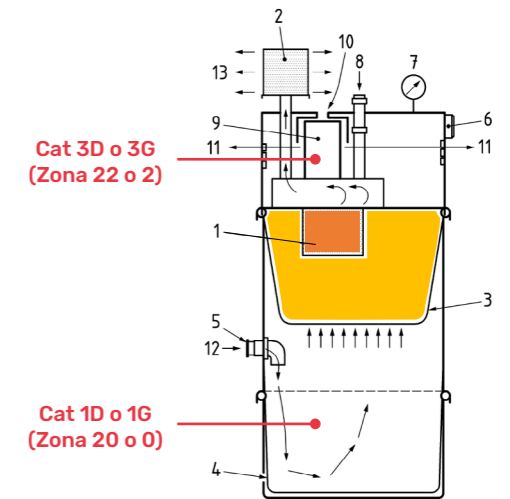

- 1 HEPA filter for working air
- 2 HEPA filter for working air exhaust
- 3 dissipative main filter
- 4 dissipative coating (optional bag)
- 5 suction inlet
- 6 switch box: Ex tb
- 7 filter clogging indicator
- 8 vacuum relief valve
- 9 motor
- 10 cooling air intake
- 11 cooling air exhaust
- 12 working air intake
- 13 working air exhaust

DELFIN EX: 3RD PARTY CERTIFIED

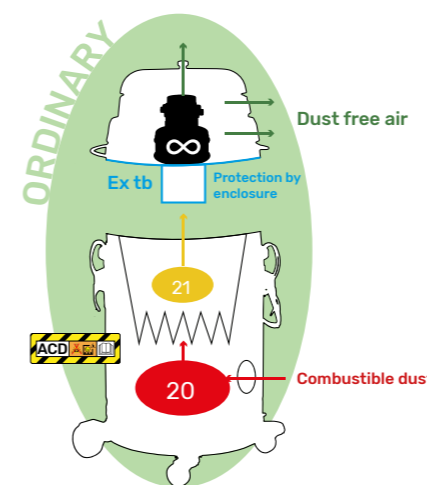

Ex Category 1/ - D
Solution designed and certified for collection of combustible dust in ordinary location / non ATEX classified

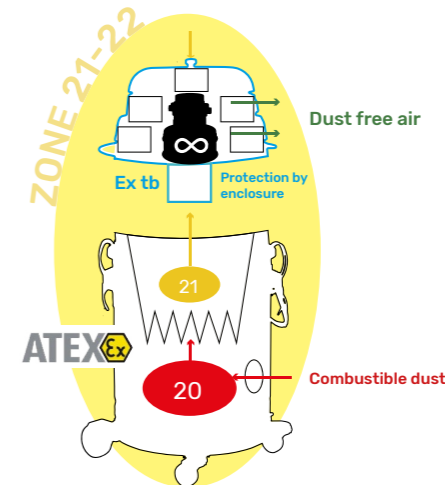

Ex Category 1/3D - 1/2D
Solution designed and certified for collection of combustible dust in Zone 22 or Zone 21

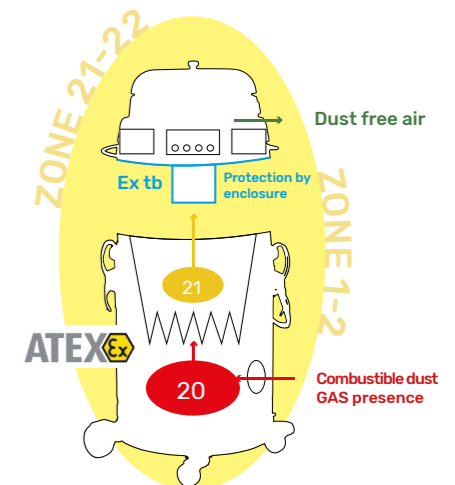

Ex Category 1/2D - 2/2G
Solution designed and certified for collection of combustible dust in Zone 1, 2, 21 and 22 in presence of flammable GAS

First number of Category make reference to the internal parts of the vacuum cleaner unit.

THE 3 TYPES OF ATEX VACS ACCORDING TO INTENDED USE

The European standard UNI EN 17348:2022 has classified ATEX vacuum cleaners based on types and applicable requirements. It has defined three different types of collectors, based on the table classifying the specific materials the vacuum cleaners are designed to collect. Instructions for safe use need to select the equipment depending on the application, the features of the flammable substances and the potential external influences.

Vacuum cleaner collectors for all categories	Substances to be collected
Dry type dust collector	Non-combustible dust
	Combustible dust
Wet type dust collector	Combustible and/or self-heating dust
Liquid collector	Non-flammable liquids
	Flammable liquids

MARKING EXPLANATION AND WARNING LABELS IN COMPLIANCE WITH THE NEW STANDARD

CE  1/2D EX h tb IIIC T80°C (INTERNAL) / T95°C (EXTERNAL) Da/Db

REF.	ELEMENT
II	Equipment group 2 - intended for use in surface industries
1 / 2	Category 1 / 2 - equipment designed with a very high level of protection inside, and a high level of protection outside. It also indicates conformity of use with the presence of internal Zone 20 and external Zone 21
D	D relates to explosive atmospheres because of the presence of combustible DUST
Ex h	Level of protection provided by construction safety, non-electrical type protection
t	Level of protection provided for dust-proofing, electrical type protection
IIIC	Subgroup of permissible, conductive-type DUSTS (e.g. metal dust)
T80°/T95°C	Max. surface temperature of marking for internal and external part of the machine - for Dust
Da/Db	Da (interna) Db (esterna) EPL for Dust group

DRY TYPE DUST COLLECTOR (EN 17348 DT)

Delfin vacuum cleaner systems are designed for the collection of dry dust of all types, combustible or non-combustible, in any mix except where self-heating dust and/or chemical aggressive substances result from the mixing. **Delfin's solutions achieve filtration level 1 with an efficiency of 99,9% and filtration level 2 of 99,995%.**



WET TYPE DUST COLLECTOR (EN 17348 WT)

Delfin wet type dust collectors are designed to efficiently precipitate and neutralize the collected combustible dust, including hot particles, or self-heating dust which otherwise can act as a source of ignition inside the collection tank. **Delfin's solutions was tested according the new standard to grant less than 5 % dust weight collected in the coalescing + HEPA filter.**



LIQUID COLLECTOR (EN 17348 LC)

Delfin designed solutions for the collection in ATEX zones of liquids non-flammable. A mechanical system grants the suction cut-off system when the tank is full. **Delfin's dual use solutions allow by using the proper filtration kit, vacuum unit suitable to be a Dry type or a Liquid collector according needs.**

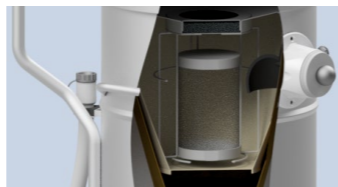

Our range of solutions covers worldwide requirements for all countries with third party certification of notified bodies, in detail:

- EU-TYPE EXAMINATION CERTIFICATE FOR ATEX IN EUROPE
- AUTHORIZATION TO MARK RECOGNISED FOR NORTH AMERICA
- CERTIFICATE OF CONFORMITY COC FOR IECEx INTERNATIONALLY

COMBUSTIBLE DUST IN ORDINARY LOCATION: THE NEW ACD LABEL

The ACD safety label was introduced with the new international product standard IEC 60335-2-69 for vacuum cleaner systems, published in 2021. This classification is aimed at increasing the safety level in non-ATEX areas, i.e. **ordinary locations where however there is a need to collect combustible dust.**



In many applications workspace is not ATEX classified even if dust is present in the process of production. This is possible because dust is well contained, and the areas are always cleaned. These areas are considered ordinary locations and equipment is not required to be ATEX certified. Vacuum cleaner systems are just for this reason, preventing dust dispersion, collecting directly from inside of other machinery, at the points of dust emission, of during maintenance.

 II 1/-D Ex h IIIC T80°C (internal) Da/-



More than applying the ACD label, Delfin has certified ATEX the internal part of its solutions as Category 1/- through a third-party certification body to grant full conformity of products to ATEX regulation.

These Dust collectors are designed and certified as Zone 20 internally compliant, granting higher safety requirements than an ordinary vacuum, even when Atex is not mandatory. They are designed and certified not to generate ignition sources, and to collect and contain safely combustible dust, thus guaranteeing both the workplace's and the worker's safety.

THE NEW BL/BP RANGE



Compact solution with tank 40l overall capacity on 4 wheels	Double use solution for recovery of liquid and combustible dust	Smart solution with detachable tank 20l capacity and reverse pulse filter cleaning system	Best solution with detachable tank 45l capacity and manual filter shaker	Industrial solution with detachable tank 60 to 100l with manual filter shaker	Long lasting solution with endless bag and various filter cleaning options
---	---	---	--	---	--

Wet systems available in all sizes for collection of conductive, sensitive or self igniting dusts.

FOCUS: ATEX-CERTIFIED MONOPHASE VACUUM CLEANER

Motorhead with "dust tight" protection features. Enclosure totally sealed against penetration of dust even after severe aging, temperature and mechanical impact tests.

H14/HEPA filtration to guarantee higher efficiency >99.995% (second stage of filtration)

Static dissipative filter class M as standard for primary filter with 99.9 efficiency (First stage of filtration)

Construction in stainless steel (AISI 304 or 316 available) with conductive painting or layer under 200 microns tested by break voltage

Automatic or manual self enclosed filter cleaning system

Safety cap to ensure containment during transport.

Wide range of antistatic accessories for multiple applications

Heavy duty trolley with industrial design to enable easy transport and prevent the generation of electrostatic discharges

Double grounding via chain and power cable

Wheels with brakes



EXCLUSIVE FEATURES OF THE NEW MODELS

DUST SEALED COVER UV AND THERMAL ENDURANCE RESISTANT

All electrical controls and warning indicators are protected by a transparent covering tested according to the international norms EN IEC 60079-0:2018 clause 26.10, 26.8 and 26.9.



CLOGGING FILTER INDICATOR LIGHT AND VACUUM GAUGE

To ensure constant filtration efficiency, a warning light shows when the filter is getting clogged or if the air velocity slows down (below 20 m/sec.) due to other obstructions in the suction hose or machine body.

The vacuum gauge allows the user to monitor the clogging of the filter and plan maintenance interventions accordingly. A second light shows when the machine is connected to a power supply.

ANTISTATIC RUBBER SPARKS PROOF DEFLECTOR

Delfin designed a series of deflectors or protection systems to avoid sparks generation during collection in the filtration chamber or in the wet collector systems for high sensitivity of self-heating dust.

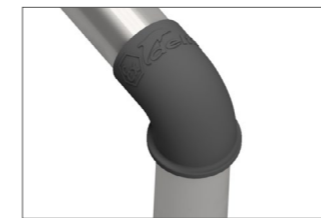

HIGH PERFORMANCE STATIC DISSIPATIVE MAIN FILTER

Burst strength test and collapsing test were performed to the main filter to ensure long lasting resistance in heavy duty applications according to the new 17348 standard, as primary level of filtration. Resistances below $10^8 \Omega$ according EN 17348.



INDIVIDUALLY TESTED HEPA FILTERS AS ESSENTIAL ELEMENT FOR SAFETY

High-efficiency particle air filters are individually tested to grant 99.995% of efficiency as secondary level of filtration with 100% quality control and traceability by serial number.



ACCESSORIES, TOOLS AND NON-METALLIC PARTS

All ATEX Delfin accessories, tools and non-metallic parts are compliant with the new standard EN17348 granting surface and transversal resistances below $10^8 \Omega$ according EN 17348.



REDUCTION OF NOISE AT DESIGN STAGE

The vacuum cleaners are designed and constructed in such a way that risks resulting from the emission of airborne noise are reduced to the lowest level possible according to the state of the art and taking into account the information and technical measures given in EN ISO 11688-1:2009

VIBRATION HAZARDS

Vacuum cleaners are designed and constructed in such a way to reduce operator exposure to hand transmitted vibration to the lowest level according to the state of the art and taking into account the possible measures to reduce this risk at the source, measuring the hand-transmitted vibration total value according EN ISO 20643:2008 at the maximum rated power

ATEX CENTRALISED VACUUM SYSTEMS

When it is necessary to vacuum in large working environments, with large distances to cover and in several points at the same time, a centralized vacuum system represents the most effective solution to adopt. The system makes it possible to remove material in different points of the company, even from machinery integrated in the production process, and to store the material in a single point of the company for easy disposal or recovery. The suction systems therefore make it possible to improve company productivity and at the same time improve working conditions and safety standards for workers.

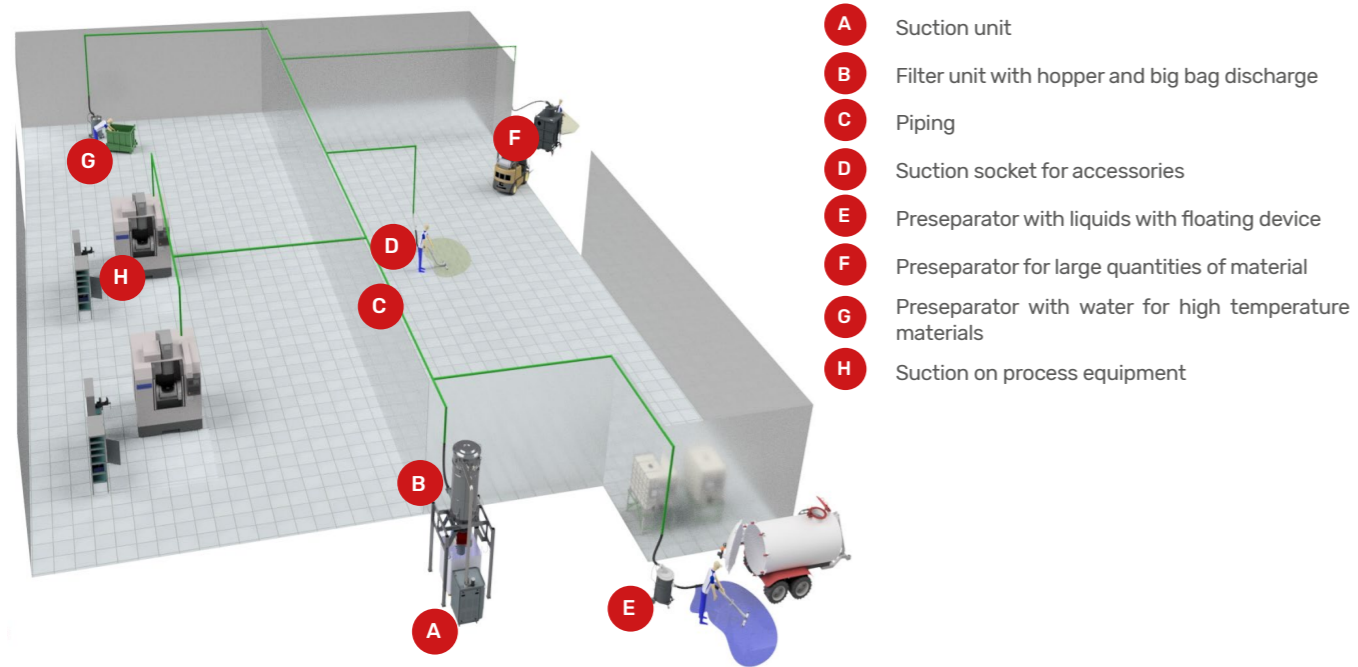

- A** Suction unit
- B** Filter unit with hopper and big bag discharge
- C** Piping
- D** Suction socket for accessories
- E** Preseparator with liquids with floating device
- F** Preseparator for large quantities of material
- G** Preseparator with water for high temperature materials
- H** Suction on process equipment

DOUBLE LEVEL OF FILTRATION EXPLOSION RESISTANT VACUUM SYSTEM

Delfin, through its technical department, and long experience in the design, manufacture and installation of ATEX-compliant systems, develops and offers state-of-the-art solutions to meet the countless needs of industrial processes.

All our centralized filtration systems are provided with two filtrations levels to manage internal Zone 20 and allow to use a category 3D vacuum fan. Our system of filtration is designed to grant HEPA Efficiency downstream and to ensure a secondary protection in case of failure of main filter, avoiding to the dust get into contact with the power system.

Our range offer a wide range of power from 3 to 45KW, from 300 to 2300mc/h, from 3200 to 8200mmH₂O

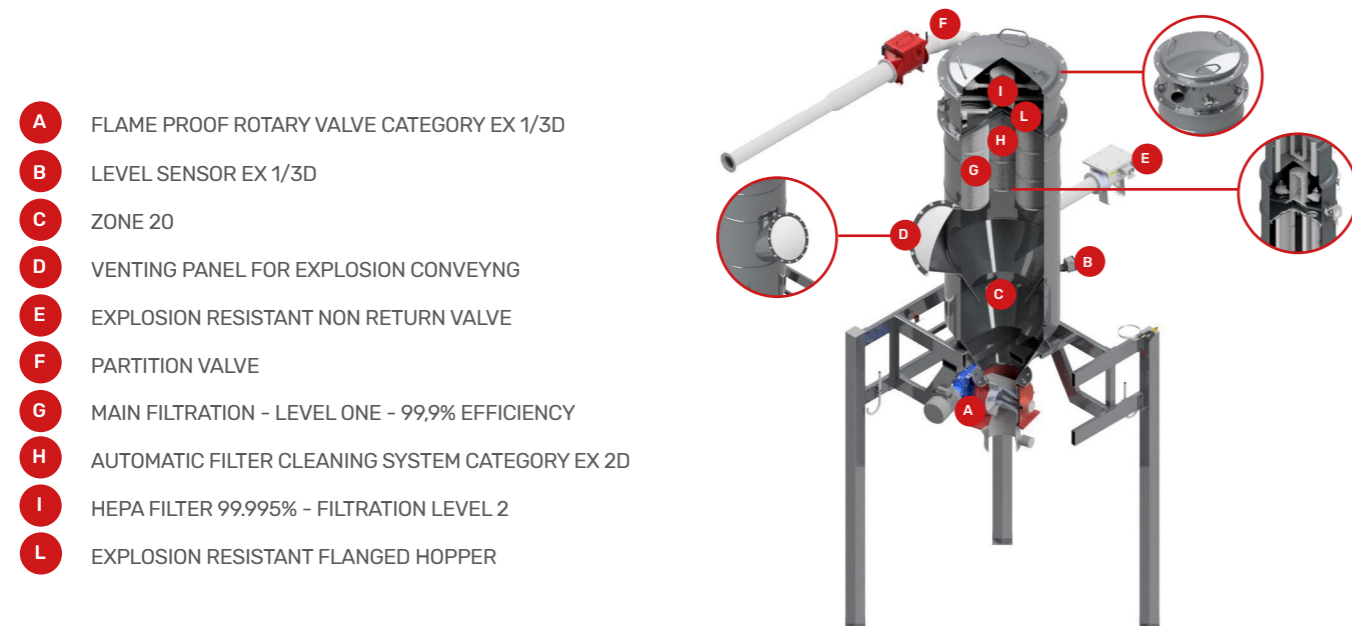

- A** FLAME PROOF ROTARY VALVE CATEGORY EX 1/3D
- B** LEVEL SENSOR EX 1/3D
- C** ZONE 20
- D** VENTING PANEL FOR EXPLOSION CONVEYING
- E** EXPLOSION RESISTANT NON RETURN VALVE
- F** PARTITION VALVE
- G** MAIN FILTRATION - LEVEL ONE - 99,9% EFFICIENCY
- H** AUTOMATIC FILTER CLEANING SYSTEM CATEGORY EX 2D
- I** HEPA FILTER 99,995% - FILTRATION LEVEL 2
- L** EXPLOSION RESISTANT FLANGED HOPPER

COMBUSTIBLE DUST PROPERTIES AND EXPLOSIVENESS PARAMETERS

These are the main parameters that define the dust level of danger

- Pmax (Maximum explosion pressure) bar
- Kst (Deflagration constant) bar*m/s
- St (Explosion class)
- MIE (Minimum ignition energy) mJ
- MIT (Minimum cloud ignition temperature) °C
- LIT (Ignition temperature of the 5 mm layer) °C
- LEL (Lower Explosive Limit) g/M³

Thanks to these parameters, it will be possible to carry out the calculation report for the filter separator and also to dimension the characteristics of the following explosion management system, non prevention system:

- Prevention systems
- Protection systems
- Isolation systems
- Suppression systems

DELFIN SOLUTION TO MANAGE EXPLOSION IN CENTRALISED SYSTEMS

PROTECTION SYSTEMS IN THE FILTER

Explosion venting systems are designed to open at a predetermined pressure to allow the pressure front and flame front to vent in the desired direction in a safe area. Easy to install and highly efficient, rupture vent panels are integrated to the filtration chamber of the hopper. They are available in a variety of sizes, configurations and materials to ensure reliable and rapid operation in the event of an explosion. Available in flameless version.

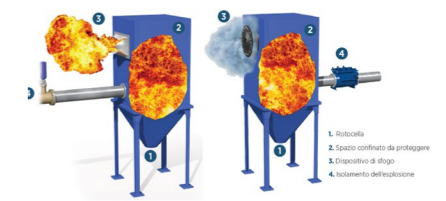

INSULATION SYSTEMS

Delfin isolation systems are designed to detect an explosion and intervene to minimise the risk of the deflagration propagating between interconnected process equipment. They have to be installed in combination with protection system.

The mechanical isolation method can be designed using an 'Active' product such as the Quick Slide Valve or a 'Passive' product such as the Flap Valve. Each of these solutions provides a mechanical barrier that isolates the deflagration.



FILTER SUPPRESSION SYSTEMS

Within milliseconds, the explosion suppression system is able to detect the pressure build-up in the initial stages of an explosion and consequently discharge the contents of a suppressor into the confined space before the pressure can reach destructive capacity. The suppressor works by interfering with the explosion reaction, removing heat from the flame front of the deflagration and thereby reducing the temperature below that required to sustain combustion. The explosion suppressor also creates a barrier between the combustible particles to prevent further heat transfer.

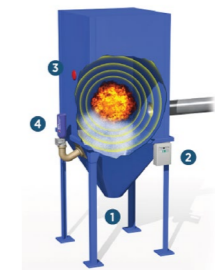

PRE-FILTER PREVENTION AND SHUTDOWN SYSTEMS

Spark detection and extinguishing systems are designed to prevent dust explosions and fires by detecting sparks and extinguishing them automatically.

The small amount of water used for extinguishing, about five litres, does not damage filters or other production machinery. Once the danger has been eliminated, the system automatically stops the extinguishing process and is ready to intervene immediately at the next passage of sparks or hot bodies. These can be used in a wide range of industries, including: Wood Processing, Bioenergy, Waste Recycling, Paper, Food, Textiles and Plastics.

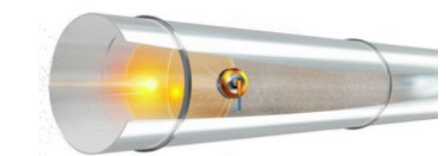

ATEX PNEUMATIC CONVEYOR BY DELFIN

Pneumatic conveying is a system widely used in the food, agro-food, nutraceutical, pharmaceutical and chemical industries. These systems allow the transfer, through closed/hermetic pipes, of bulk materials in powder or granule form, from one starting point to another, eliminating the risk of contamination and dispersion of dusts.

The passage of a gaseous flow inside the pipes creates a (negative) pressure difference that allows the material to move forward. The gas commonly used is air, but in industrial sectors such as the chemical and pharmaceutical sectors, nitrogen is often required because, being inert, it is the ideal choice with potentially explosive materials.

The use of suitable conveyor systems for handling powders between the different processing machines can make all the difference in the quality of the final product and in the safety of the working environment.

Pneumatic conveyors are used in many types of industries and their use can increase productivity by up to 30% and the efficiency of the automatic machines on which they are installed, more than reduce the risk of explosion.



- Full customization and programming service
- Ex Electrical panel with controls setting display
- Automatic filter cleaning system
- 2 levels of filtrations with HEPA efficiency
- Manual or automatic loading pick up
- Counterweight flap, butterfly or clapet discharge systems
- ATEX valves and sensors for safety management
- ATEX vibration systems
- AISI 304 Stainless steel & FDA compliance
- Internal mirror finishing

HOW TO CHOOSE THE PERFECT INDUSTRIAL SOLUTION FOR YOUR NEEDS

Making a consistent choice on the vacuum cleaners, pneumatic conveying, or plant engineering solution customized to your specific production needs is fundamental to ensuring a workplace prioritizing safety, health, and maintenance with best performance. The decision hinges primarily on factors such as the type of application, handled material, operating hours, and production plant features.

Delfin's Engineering team is available to design and propose the best suitable solution:

1- SERIES MODELS READY TO USE FOR ANY NEEDS OF CLEANING

2- CUSTOMISED VACUUM CLEANER SYSTEMS FOR SPECIFIC APPLICATION

3- CENTRALISED VACUUM SYSTEM DESIGNED ON PROJECT

4- PNEUMATIC CONVEYORS TO INCREASE PRODUCTION SAFETY AND PERFORMANCE

These are just a few of the questions you'll need to answer to help us steer you towards the perfect solution for your requirements. Our dedicated forms allow us to gather all the relevant information about your industry and applications, crucial for designing and selecting your Delfin solution together.

LET OUR EXPERTS ASSIST YOU IN ACHIEVING YOUR GOALS!

CONTACT US TO GET THE FORM!
delfin@delfinvacuums.it

WHY CHOOSE DELFIN



MADE IN ITALY

Delfin manufactures all its products in Italy. We represent "Made in Italy" by promoting the excellence of our products throughout the world.



VISION

Delfin is a company that never stops growing and innovating. We create value with the aim of growing together with our partners.



MISSION

Every day we create innovative solutions to guarantee safety and increase productivity.



CUSTOMIZATION

We customized solutions according to our customers requirements, thanks to our R&D department and in-house production processes.



BUFFERSTOCK

Best sellers always available in stock. The Bufferstock is a commitment to the customer to offer an incomparable delivery service..



SERVICE CHAIN

We dedicate to each customer a team of specialists in each department, for a direct communication with our company.

Delfin is a global leader in the manufacturing of industrial vacuum equipment, ranging from portable vacuums for industrial cleaning, to central vacuum systems and engineered solutions, to pneumatic conveying systems. Our mission is to create value by designing innovative solutions that improve efficiency, safety, and productivity. Our aim is to use our expertise to help our customers to achieve their goals.



Delfin Srl • Strada della Merla 49/A • 10036 Settimo T.se (To) Italy
Tel +39 011 800 55 00
delfin@delfinvacuums.it • delfinvacuums.com